

FEATURES

- **LOW COST PLASTIC SURFACE MOUNT PACKAGE**
- **HIGH OUTPUT POWER:** +26 dBm TYP at $V_{DS} = 3.0$ V
- **HIGH LINEAR GAIN:** 11 dB TYP @ 2.45 GHz
- **SINGLE SUPPLY:** 2.8 to 6 V
- **SURFACE MOUNT PACKAGE:** 5.7x5.7x1.1 mm MAX

OUTLINE DIMENSIONS (Units in mm)

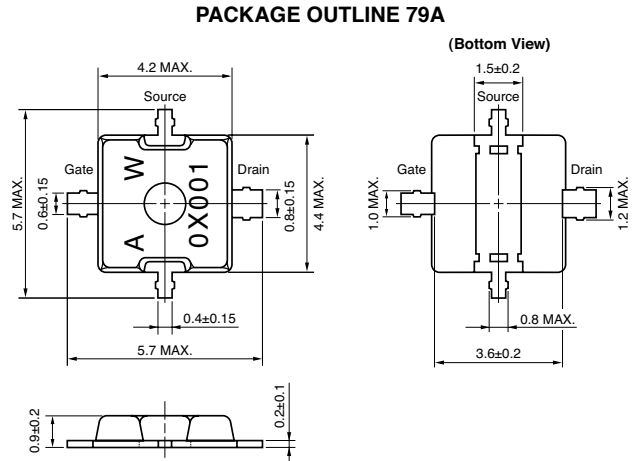

DESCRIPTION

NEC's NE552R479A is an N-Channel silicon power laterally diffused MOSFET specially designed as the transmission power amplifier for mobile and fixed wireless applications. Die are manufactured using NEC's NEWMOS2 technology (NEC's 0.6 μ m WSi gate lateral MOSFET) and housed in a surface mount package.

APPLICATIONS

- **DIGITAL CELLULAR PHONES:**
3.0 V GSM1900 Pre Driver
- **ANALOG CELLULAR PHONES:**
2.4 V AMPS Handsets
- **OTHERS:**
W-LAN
Short Range Wireless
Retail Business Radio
Special Mobile Radio

ELECTRICAL CHARACTERISTICS ($T_A = 25^\circ\text{C}$)

PART NUMBER PACKAGE OUTLINE				NE552R479A 79A			TEST CONDITIONS
Functional Characteristics	SYMBOLS	CHARACTERISTICS	UNITS	MIN	TYP	MAX	
		P_{OUT}	Output Power	dBm	24.0	26.0	
	G_L	Linear Gain	dB		11.0		
	η_{ADD}	Power Added Efficiency	%	35	45		
	I_D	Drain Current	A		230		
Electrical DC Characteristics	I_{GSS}	Gate-to-Source Leakage Current	nA			100	$V_{GS} = 5.0$ V
	I_{DSS}	Saturated Drain Current (Zero Gate Voltage Drain Voltage)	nA			100	$V_{DS} = 6.0$ V
	V_{TH}	Gate Threshold Voltage	V	1	1.4	1.9	$V_{DS} = 3.5$ V, $I_{DS} = 1$ mA
	g_m	Transconductance	S		0.4		$V_{DS} = 3.5$ V, $I_{DS} = 100$ mA
	BV_{DSS}	Drain-to-Source Breakdown Voltage	V	15	18		$I_{DSS} = 10$ μ A
	R_{TH}	Thermal Resistance	$^\circ\text{C/W}$			10	Channel-to-Case

Notes:

1. DC performance is tested 100%. Several samples per wafer are tested for RF performance. Wafer rejection criteria for standard devices is 1 reject for several samples.

ABSOLUTE MAXIMUM RATINGS¹ (T_A = 25 °C)

SYMBOLS	PARAMETERS	UNITS	RATINGS
V _{DS}	Drain Supply Voltage	V	15.0
V _{GS}	Gate Supply Voltage	V	5.0
I _{DS}	Drain Current	mA	300
I _{DS}	Drain Current (Pulse Test) ²	mA	600
P _T	Total Power Dissipation	W	10
T _{CH}	Channel Temperature	°C	125
T _{STG}	Storage Temperature	°C	-55 to +125

Notes:

1. Operation in excess of any one of these parameters may result in permanent damage.
2. Duty cycle 50%, T_{on} ≤ 1 s.

ORDERING INFORMATION

PART NUMBER	QTY
NE552R479A-T1A-A	<ul style="list-style-type: none"> • 12 mm wide embossed taping. • Gate pin faces the perforation side of the tape. • 5 kpcs/Reel

RECOMMENDED OPERATING LIMITS

SYMBOLS	PARAMETERS	UNITS	TYP	MAX
V _{DS}	Drain to Source Voltage	V	3.0	6.0
V _{GS}	Gate Supply Voltage	V	2.0	3.0
I _{DS}	Drain Current ¹	mA	200	500
P _{IN}	Input Power ²	dBm	19	25

Notes:

1. Duty cycle 50%, T_{on} ≤ 1 s.
2. f = 2.45 GHz, V_{DS} = 3.0 V.

LARGE SIGNAL IMPEDANCE

(V_{DS} = 3.0 V, I_D = 200 mA, f = 2.45 GHz, P_{out} = 400 mW)

FREQUENCY (GHz)	Z _{in} (Ω)	Z _{OL} (Ω) ¹
2.45	2.96 -j7.78	3.36 -j8.42

Note:

1. Z_{OL} is the conjugate of optimum load impedance at given voltage, idling current, input power and frequency.

TYPICAL PERFORMANCE CURVES (T_A = 25°C)

TOTAL POWER DISSIPATION vs. CASE TEMPERATURE

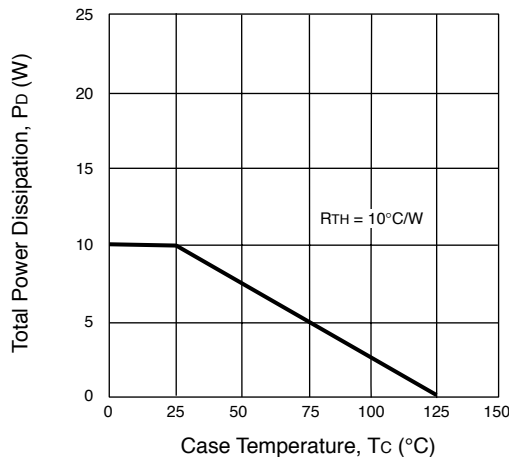

DRAIN CURRENT vs. DRAIN VOLTAGE

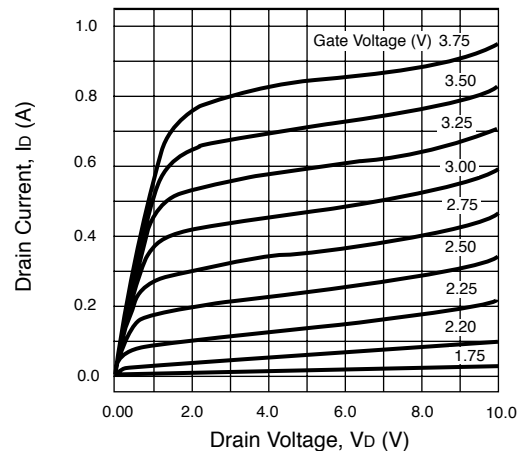

TYPICAL PERFORMANCE CURVES ($T_A = 25^\circ\text{C}$)

OUTPUT POWER, DRAIN CURRENT EFFICIENCY vs. INPUT POWER

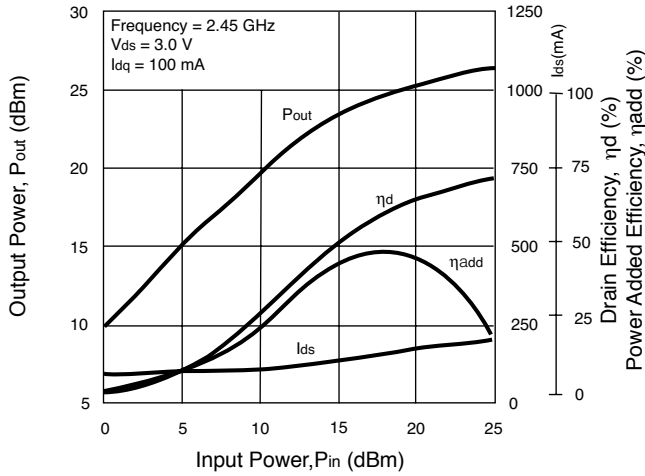

OUTPUT POWER, DRAIN CURRENT EFFICIENCY vs. GATE TO SOURCE VOLTAGE

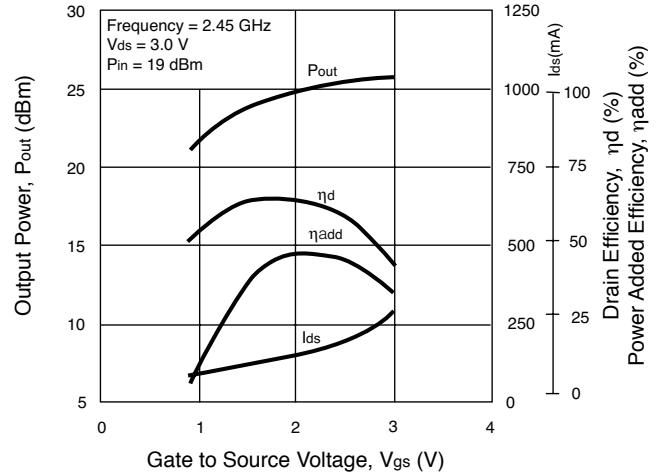

OUTPUT POWER, DRAIN CURRENT EFFICIENCY vs. INPUT POWER

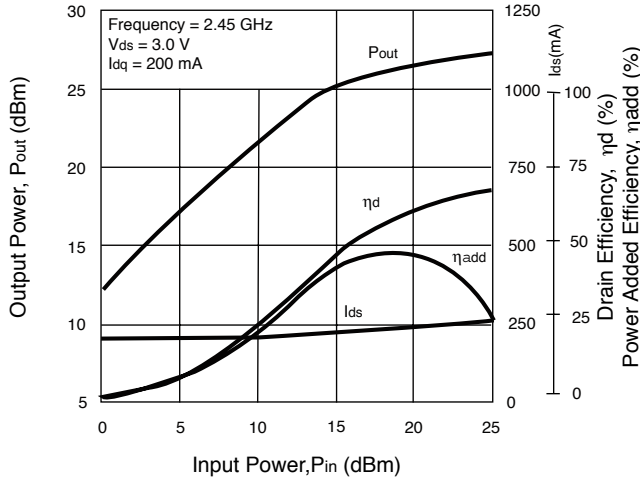

IMD vs. TWO TONE OUTPUT POWER

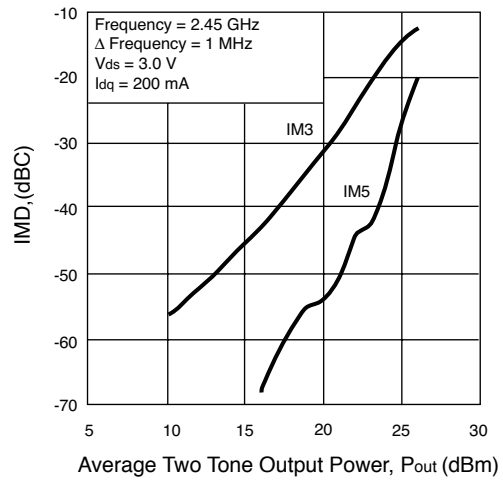

OUTPUT POWER, DRAIN CURRENT EFFICIENCY vs. INPUT POWER

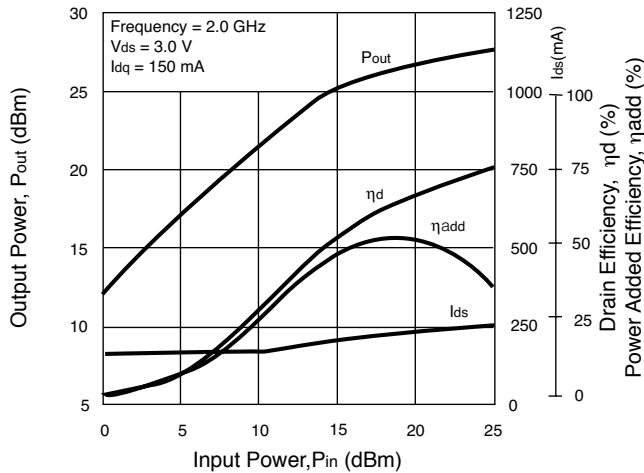

OUTPUT POWER, DRAIN CURRENT EFFICIENCY vs. GATE TO SOURCE VOLTAGE

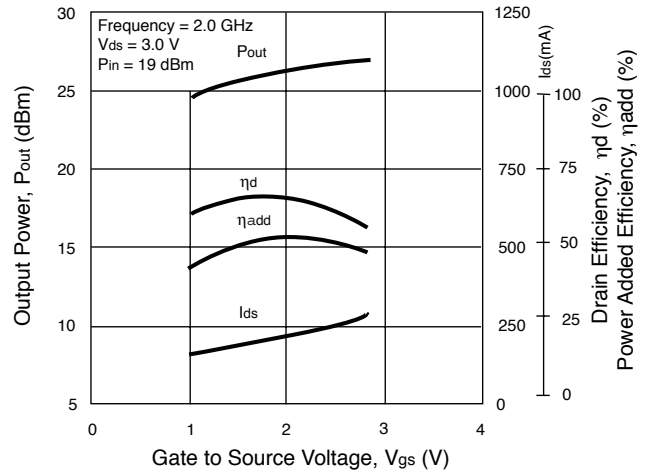

NE552R479A

TYPICAL SCATTERING PARAMETERS (T_A = 25°C)

Note: This file and many other s-parameter files can be downloaded from www.cel.com

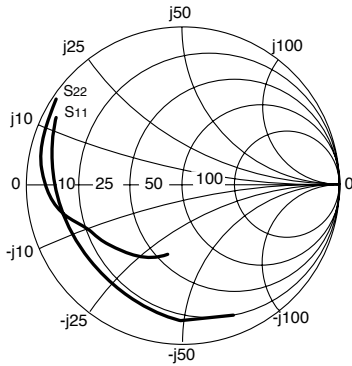

Coordinates in Ohms
Frequency in GHz
V_D = 2.4 V, I_D = 50 mA

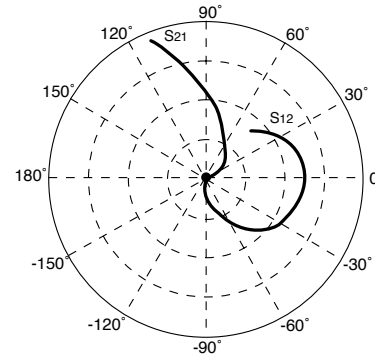

NE552R479A

V_D = 2.4 V, I_D = 50 mA

FREQUENCY GHz	S ₁₁		S ₂₁		S ₁₂		S ₂₂		K	MAG ¹ (dB)
	MAG	ANG	MAG	ANG	MAG	ANG	MAG	ANG		
0.10	0.877	-70.3	13.863	135.4	0.042	46.6	0.452	-104.4	0.05	25.15
0.20	0.806	-108.8	9.339	111.6	0.057	23.4	0.569	-132.8	0.05	22.13
0.30	0.775	-129.7	6.708	97.4	0.061	9.6	0.614	-145.1	0.07	20.43
0.40	0.764	-142.5	5.130	87.2	0.062	0.6	0.641	-151.6	0.09	19.17
0.50	0.760	-151.0	4.102	79.2	0.061	-7.0	0.663	-155.4	0.12	18.24
0.60	0.765	-157.3	3.378	72.3	0.060	-13.0	0.681	-158.2	0.14	17.49
0.70	0.771	-162.3	2.846	66.1	0.059	-18.2	0.699	-160.3	0.17	16.85
0.80	0.781	-166.4	2.437	60.6	0.057	-23.0	0.717	-161.9	0.20	16.32
0.90	0.792	-170.0	2.113	55.5	0.055	-27.3	0.734	-163.4	0.22	15.86
1.00	0.805	-173.2	1.854	50.6	0.053	-31.4	0.751	-164.8	0.23	15.46
1.10	0.816	-176.0	1.644	46.2	0.051	-34.8	0.770	-166.0	0.23	15.11
1.20	0.829	-178.7	1.458	41.7	0.048	-38.5	0.781	-167.7	0.27	14.80
1.30	0.838	178.6	1.304	37.5	0.046	-41.8	0.793	-169.1	0.31	14.53
1.40	0.848	176.4	1.172	33.7	0.044	-44.9	0.806	-170.4	0.33	14.29
1.50	0.855	174.2	1.057	30.0	0.041	-47.6	0.818	-171.7	0.38	14.07
1.60	0.861	172.2	0.958	26.5	0.039	-50.3	0.830	-173.1	0.43	13.89
1.70	0.866	170.3	0.871	23.3	0.037	-52.4	0.841	-174.5	0.49	13.72
1.80	0.872	168.5	0.795	20.3	0.035	-54.4	0.851	-175.9	0.56	13.61
1.90	0.877	166.8	0.729	17.3	0.033	-56.7	0.861	-177.4	0.61	13.49
2.00	0.883	165.2	0.671	14.6	0.031	-58.7	0.870	-178.8	0.65	13.39
2.10	0.889	163.8	0.619	11.9	0.029	-60.2	0.878	179.7	0.68	13.29
2.20	0.895	162.3	0.572	9.3	0.027	-62.1	0.885	178.2	0.74	13.22
2.30	0.901	161.1	0.531	6.9	0.026	-63.8	0.892	176.8	0.76	13.14
2.40	0.905	159.8	0.493	4.5	0.024	-65.6	0.898	175.2	0.82	13.07
2.50	0.909	158.8	0.459	2.2	0.023	-67.3	0.903	173.8	0.89	13.05
2.60	0.909	157.8	0.427	0.1	0.021	-68.8	0.909	172.3	1.02	12.11
2.70	0.911	157.0	0.399	-1.9	0.019	-71.4	0.914	170.8	1.19	10.52
2.80	0.910	156.3	0.373	-3.8	0.018	-74.0	0.919	169.1	1.41	9.38
2.90	0.912	155.7	0.350	-5.5	0.016	-74.2	0.924	167.5	1.55	8.93
3.00	0.912	155.1	0.329	-7.2	0.015	-74.8	0.927	166.0	1.82	8.26
3.10	0.915	154.8	0.311	-8.8	0.014	-75.5	0.932	164.4	1.90	8.13
3.20	0.916	154.2	0.294	-10.4	0.012	-77.4	0.935	162.9	2.19	7.63
3.30	0.919	153.8	0.278	-11.9	0.011	-77.8	0.939	161.3	2.41	7.39
3.40	0.920	153.4	0.263	-13.4	0.010	-79.9	0.943	159.6	2.77	7.11
3.50	0.922	153.1	0.251	-14.8	0.008	-80.8	0.948	157.9	3.15	6.98
3.60	0.923	153.0	0.239	-16.1	0.007	-78.5	0.951	156.1	3.72	6.76
3.70	0.924	153.0	0.228	-17.4	0.006	-75.4	0.953	154.1	4.29	6.58
3.80	0.924	153.1	0.217	-18.7	0.005	-73.6	0.957	152.1	4.86	6.47
3.90	0.925	153.5	0.208	-19.9	0.004	-70.4	0.960	149.6	6.62	6.36
4.00	0.925	154.1	0.200	-21.2	0.003	-50.4	0.961	146.8	9.58	5.98

Note:

1. Gain Calculation:

$$MAG = \frac{|S_{21}|}{|S_{12}|} (K \pm \sqrt{K^2 - 1}). \text{ When } K \leq 1, \text{ MAG is undefined and MSG values are used. } MSG = \frac{|S_{21}|}{|S_{12}|}, K = \frac{1 + |\Delta|^2 - |S_{11}|^2 - |S_{22}|^2}{2 |S_{12}| |S_{21}|}, \Delta = S_{11} S_{22} - S_{21} S_{12}$$

MAG = Maximum Available Gain

MSG = Maximum Stable Gain

TYPICAL SCATTERING PARAMETERS (TA = 25°C)

Note: This file and many other s-parameter files can be downloaded from www.cel.com

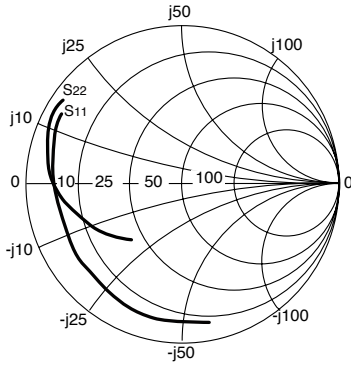

Coordinates in Ohms
Frequency in GHz
Vd = 3.5 V, Id = 200 mA

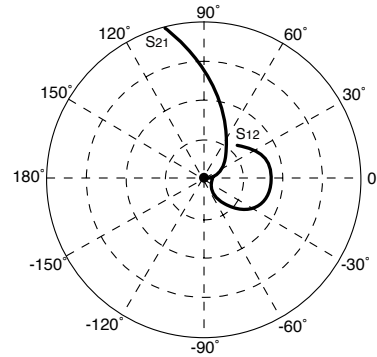

NE552R479A

Vd = 3.5 V, Id = 200 mA

FREQUENCY GHz	S11		S21		S12		S22		K	MAG ¹ (dB)
	MAG	ANG	MAG	ANG	MAG	ANG	MAG	ANG		
0.10	0.881	-80.4	17.975	132.9	0.030	44.0	0.490	-134.7	0.06	27.71
0.20	0.833	-119.4	11.643	110.6	0.039	22.1	0.623	-151.5	0.06	24.72
0.30	0.813	-139.1	8.264	98.2	0.042	10.8	0.666	-159.4	0.08	22.98
0.40	0.805	-151.0	6.317	89.6	0.042	3.3	0.689	-163.6	0.11	21.78
0.50	0.800	-158.9	5.073	82.9	0.042	-1.9	0.704	-166.2	0.14	20.83
0.60	0.801	-164.7	4.206	77.2	0.042	-6.9	0.714	-168.1	0.17	20.04
0.70	0.802	-169.3	3.577	72.1	0.041	-10.8	0.725	-169.4	0.21	19.42
0.80	0.807	-173.1	3.093	67.4	0.040	-14.2	0.735	-170.5	0.24	18.89
0.90	0.812	-176.3	2.711	63.1	0.039	-17.7	0.744	-171.5	0.26	18.42
1.00	0.820	-179.2	2.405	58.9	0.038	-20.7	0.754	-172.3	0.28	18.03
1.10	0.827	-178.4	2.158	55.1	0.037	-23.6	0.767	-173.0	0.29	17.66
1.20	0.836	-175.9	1.936	51.1	0.036	-26.4	0.773	-174.2	0.32	17.37
1.30	0.840	-173.6	1.752	47.4	0.034	-28.9	0.781	-175.1	0.37	17.06
1.40	0.847	-171.8	1.592	43.9	0.033	-30.9	0.790	-176.0	0.41	16.86
1.50	0.851	-169.8	1.452	40.4	0.032	-33.7	0.799	-176.9	0.45	16.63
1.60	0.854	-168.1	1.331	37.3	0.030	-35.5	0.808	-177.8	0.51	16.44
1.70	0.857	-166.4	1.223	34.2	0.029	-37.3	0.817	-178.8	0.58	16.28
1.80	0.861	-164.9	1.127	31.3	0.027	-39.0	0.824	-179.9	0.66	16.15
1.90	0.865	-163.5	1.044	28.4	0.026	-40.7	0.833	-178.9	0.69	15.97
2.00	0.870	-162.1	0.969	25.8	0.025	-41.6	0.841	-177.8	0.76	15.91
2.10	0.875	-160.9	0.902	23.1	0.024	-43.3	0.849	-176.7	0.81	15.82
2.20	0.880	-159.6	0.841	20.5	0.023	-44.3	0.855	-175.5	0.85	15.69
2.30	0.885	-158.5	0.786	18.0	0.022	-45.3	0.862	-174.2	0.88	15.62
2.40	0.889	-157.5	0.736	15.6	0.020	-46.9	0.869	-172.9	0.96	15.60
2.50	0.892	-156.6	0.689	13.3	0.019	-48.5	0.875	-171.6	1.03	14.40
2.60	0.893	-155.7	0.646	11.0	0.018	-49.6	0.881	-170.3	1.17	13.05
2.70	0.895	-155.0	0.607	9.0	0.017	-50.5	0.886	-169.0	1.32	12.20
2.80	0.894	-154.5	0.571	6.9	0.015	-53.1	0.891	-167.5	1.61	11.19
2.90	0.895	-153.9	0.540	5.0	0.014	-52.4	0.897	-166.1	1.81	10.71
3.00	0.896	-153.5	0.511	3.2	0.013	-50.3	0.902	-164.7	2.08	10.17
3.10	0.899	-153.2	0.485	1.5	0.012	-50.7	0.907	-163.2	2.11	10.09
3.20	0.900	-152.8	0.460	-0.3	0.011	-51.9	0.911	-161.7	2.44	9.58
3.30	0.903	-152.4	0.438	-1.9	0.010	-49.9	0.915	-160.3	2.77	9.33
3.40	0.904	-152.0	0.417	-3.6	0.009	-47.2	0.920	-158.7	3.09	9.09
3.50	0.906	-151.9	0.398	-5.1	0.008	-44.6	0.925	-157.0	3.35	8.98
3.60	0.907	-151.8	0.381	-6.7	0.007	-38.1	0.928	-155.3	3.93	8.65
3.70	0.909	-151.8	0.365	-8.3	0.006	-33.2	0.932	-153.4	4.17	8.53
3.80	0.908	-152.1	0.350	-9.7	0.005	-26.9	0.936	-151.5	4.98	8.21
3.90	0.910	-152.5	0.337	-11.2	0.005	-15.3	0.940	-149.0	4.88	8.20
4.00	0.910	-153.1	0.325	-12.8	0.005	-4.5	0.941	-146.3	4.94	7.84

Note:

1. Gain Calculation:

$$MAG = \frac{|S_{21}|}{|S_{12}|} (K \pm \sqrt{K^2 - 1})$$

When $K \leq 1$, MAG is undefined and MSG values are used. $MSG = \frac{|S_{21}|}{|S_{12}|}$, $K = \frac{1 + |\Delta|^2 - |S_{11}|^2 - |S_{22}|^2}{2 |S_{12}| |S_{21}|}$, $\Delta = S_{11} S_{22} - S_{21} S_{12}$

MAG = Maximum Available Gain

MSG = Maximum Stable Gain

APPLICATION CIRCUIT (2.40-2.48 GHz)

P.C.B. LAYOUT (Units in mm)

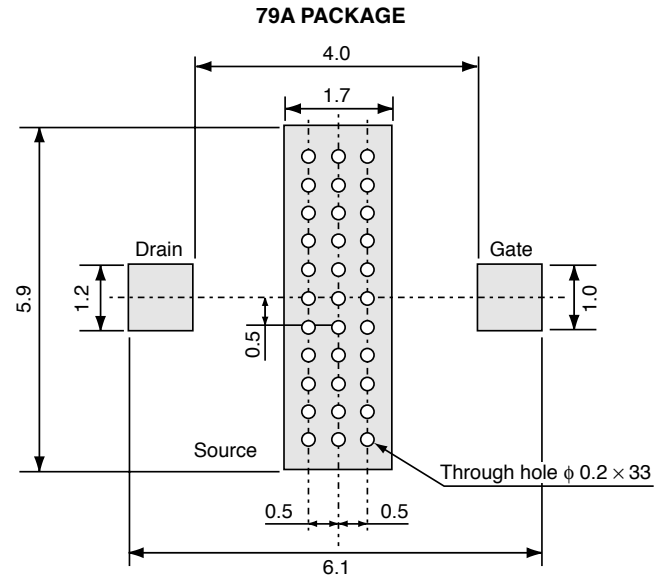
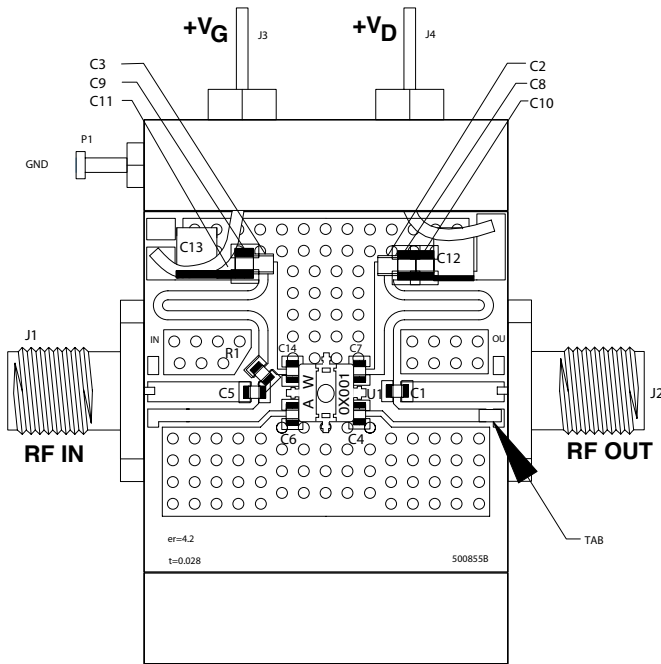

Note:
Use rosin or other material to prevent solder from penetrating through-holes.

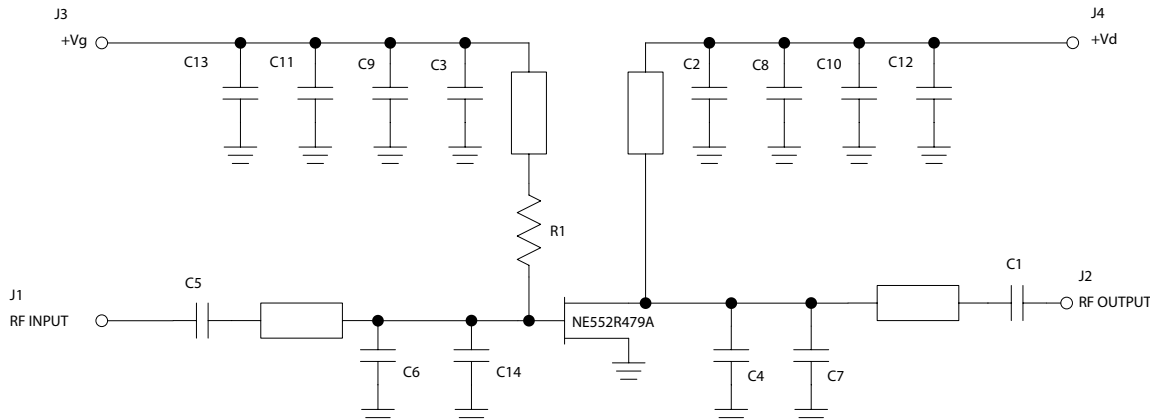

NE552R479A PARTS LIST

1	600S3R3CW	C14	0603 3.3 pF CAP ATC	17
1	TF-100637		TEST CIRCUIT BLK	15
4			2-56 x 3/16 PHILLIPS PAN HEAD	14
2	MCH185A101JK	C2,C3	0603 100pF CAP ROHM	13
1	MCR03J200	R1	0603 20 OHM RESISTOR ROHM	12
2	600S2R7BW	C4,C7	0603 2.7pF CAP ATC	11
2	600S5R6CW	C1,C5	0603 5.6pF CAP ATC	10
1	600S1R5CW	C6	0805 1.5pF CAP ATC	9
2	TAJB475K010R	C12, C13	CASE B 4.7 uF CAP AVX	8
2	MCH215F104ZP	C10, C11	0805 .1uF CAP ROHM	7
2	0805CG102J9BB04	C8, C9	0805 1000 pF CAP PHIL6	
1	NE552R479A	U1	IC NEC	5
1	703401	P1	GROUND LUG CONCORD	4
1	1250-003	J3, J4	FEEDTHRU MURATA	3
2	2052-5636-02	J1, J2	FLANGE MOUNT JACK RECEPTACLE	2
1	FD-500855B	PCB	S-BAND MODULE FABRICATION DRAWING	1

TYPICAL APPLICATION CIRCUIT PERFORMANCE (TA = 25°C)

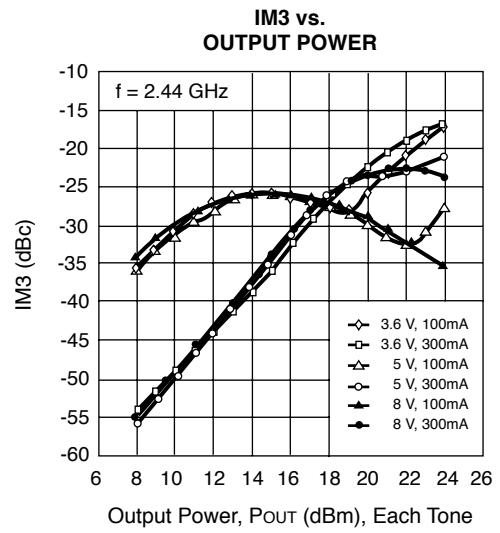
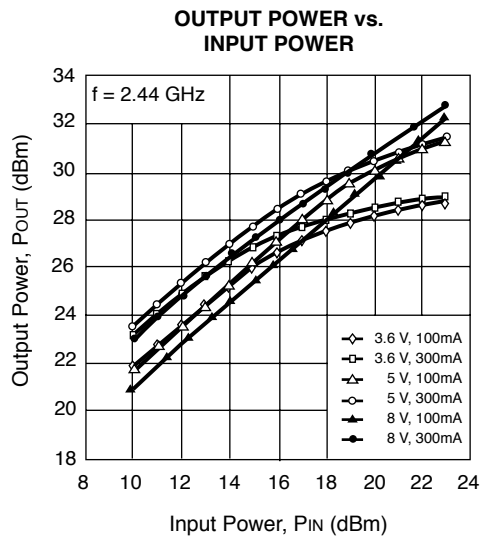

RECOMMENDED SOLDERING CONDITIONS

This product should be soldered and mounted under the following recommended conditions. For soldering methods and conditions other than those recommended below, contact your nearby sales office.

Soldering Method	Soldering Conditions	Condition Symbol
Infrared Reflow	Peak temperature (package surface temperature) : 260°C or below Time at peak temperature : 10 seconds or less Time at temperature of 220°C or higher : 60 seconds or less Preheating time at 120 to 180°C : 120±30 seconds Maximum number of reflow processes : 3 times Maximum chlorine content of rosin flux (% mass) : 0.2%(Wt.) or below	IR260
VPS	Peak temperature (package surface temperature) : 215°C or below Time at temperature of 200°C or higher : 25 to 40 seconds Preheating time at 120 to 150°C : 30 to 60 seconds Maximum number of reflow processes : 3 times Maximum chlorine content of rosin flux (% mass) : 0.2%(Wt.) or below	VP215
Wave Soldering	Peak temperature (molten solder temperature) : 260°C or below Time at peak temperature : 10 seconds or less Preheating temperature (package surface temperature) : 120°C or below Maximum number of flow processes : 1 time Maximum chlorine content of rosin flux (% mass) : 0.2%(Wt.) or below	WS260
Partial Heating	Peak temperature (pin temperature) : 350°C or below Soldering time (per pin of device) : 3 seconds or less Maximum chlorine content of rosin flux (% mass) : 0.2%(Wt.) or below	HS350-P3

Caution Do not use different soldering methods together (except for partial heating).

Life Support Applications

These NEC products are not intended for use in life support devices, appliances, or systems where the malfunction of these products can reasonably be expected to result in personal injury. The customers of CEL using or selling these products for use in such applications do so at their own risk and agree to fully indemnify CEL for all damages resulting from such improper use or sale.

CEL California Eastern Laboratories, Your source for NEC RF, Microwave, Optoelectronic, and Fiber Optic Semiconductor Devices.
 4590 Patrick Henry Drive • Santa Clara, CA 95054-1817 • (408) 988-3500 • FAX (408) 988-0279 • www.cel.com

DATA SUBJECT TO CHANGE WITHOUT NOTICE

08/11/2003

Subject: Compliance with EU Directives

CEL certifies, to its knowledge, that semiconductor and laser products detailed below are compliant with the requirements of European Union (EU) Directive 2002/95/EC Restriction on Use of Hazardous Substances in electrical and electronic equipment (RoHS) and the requirements of EU Directive 2003/11/EC Restriction on Penta and Octa BDE.

CEL Pb-free products have the same base part number with a suffix added. The suffix –A indicates that the device is Pb-free. The –AZ suffix is used to designate devices containing Pb which are exempted from the requirement of RoHS directive (*). In all cases the devices have Pb-free terminals. All devices with these suffixes meet the requirements of the RoHS directive.

This status is based on CEL’s understanding of the EU Directives and knowledge of the materials that go into its products as of the date of disclosure of this information.

Restricted Substance per RoHS	Concentration Limit per RoHS (values are not yet fixed)	Concentration contained in CEL devices	
		-A	-AZ
Lead (Pb)	< 1000 PPM	Not Detected	(*)
Mercury	< 1000 PPM	Not Detected	
Cadmium	< 100 PPM	Not Detected	
Hexavalent Chromium	< 1000 PPM	Not Detected	
PBB	< 1000 PPM	Not Detected	
PBDE	< 1000 PPM	Not Detected	

If you should have any additional questions regarding our devices and compliance to environmental standards, please do not hesitate to contact your local representative.

Important Information and Disclaimer: Information provided by CEL on its website or in other communications concerning the substance content of its products represents knowledge and belief as of the date that it is provided. CEL bases its knowledge and belief on information provided by third parties and makes no representation or warranty as to the accuracy of such information. Efforts are underway to better integrate information from third parties. CEL has taken and continues to take reasonable steps to provide representative and accurate information but may not have conducted destructive testing or chemical analysis on incoming materials and chemicals. CEL and CEL suppliers consider certain information to be proprietary, and thus CAS numbers and other limited information may not be available for release.

In no event shall CEL’s liability arising out of such information exceed the total purchase price of the CEL part(s) at issue sold by CEL to customer on an annual basis.

See CEL Terms and Conditions for additional clarification of warranties and liability.